

 **PAVISORTE**

SINCE 2016



**PRODUCT
CATALOG**



WE HELP YOU OPEN CLUBS FASTER AND REDUCE THE TOTAL COST OF YOUR SPORTS SURFACES.

What do you gain by working with us?



D2D delivery: comprehensive collection, transport and delivery of your shipments directly from the sender to the recipient



Full financial flexibility (no MOQ for bestsellers): you order only what you need and don't tie up your cash in the goods



One partner, many possibilities: we offer consulting, design, production and installation of surfaces - you only bring the equipment and you can open the premises



Support and quality assurance: the highest quality products and a partnership that understands and supports your business



Ecological solution: we will collect and process your used floor into granulate - a benefit for you and the environment



Safety and certainty of execution: we are able to produce even 3,000 tons of flooring per month, which guarantees continuity and timely deliveries

PAVI SORTE AND EWMET HAVE BEEN OPERATING IN THE RUBBER
PRODUCTS MARKET SINCE 2000

TOGETHER WE HAVE PRODUCED OVER 50,000 TONS OF PRODUCTS



HISTORY WRITTEN TOGETHER

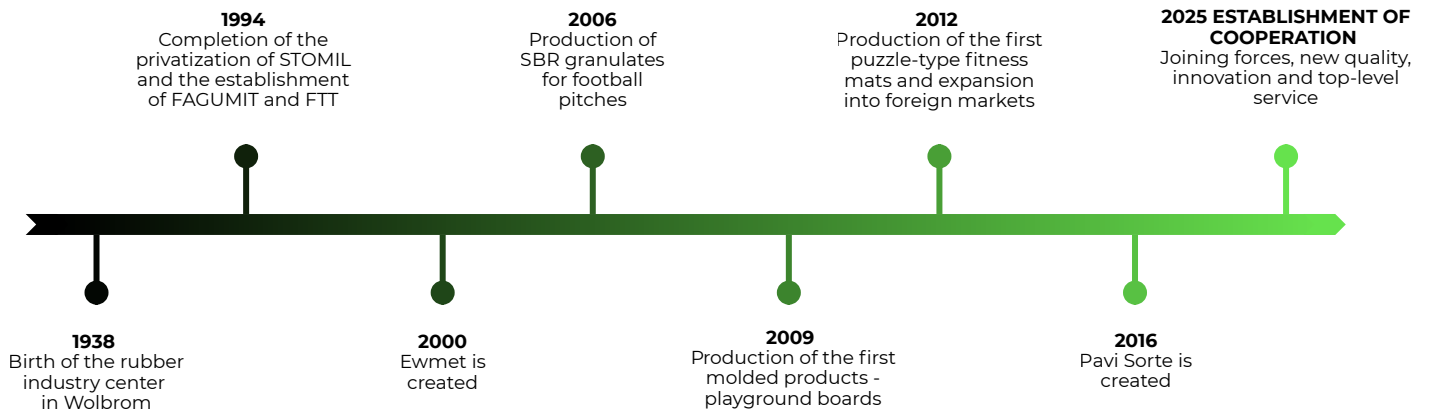

SEE OUR PRODUCTION FACILITIES

Visit our factories and see how we create surfaces that optimize the costs of your investment.

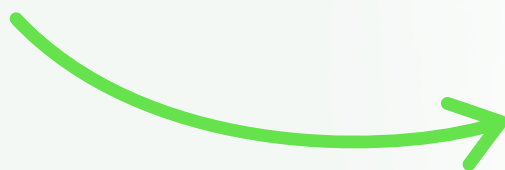

OUR NEW MISSION

The low price per square meter of rubber is often an illusion, shattered when confronted with the costs of waste, damaged screed, and expensive disposal. Learn how our TCO model eliminates hidden costs at each of the six stages of the investment, transforming logistical chaos into tangible savings.



Consulting: before we produce anything, we select the density and thickness of the rubber for specific loads (e.g., free-weight zones). This protects the screed and eliminates the risk of errors.



Custom design: we draw zones based on the floor plan. We produce material exactly to size (from a block or mold). We eliminate 15% of installation waste.



Delivery: we deliver your goods to your door on time. Zero downtime on site.

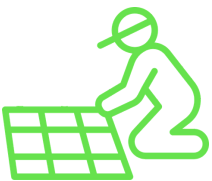

Installation: our team comes in and installs the flooring. We take the logistical burden off your subcontractors.



Service: we educate cleaning crews to help maintain the surface during its use, which helps extend its life, its vitality.



Disposal: when the floor reaches the end of its useful life, we collect it for recycling for a symbolic 1 €. The investor pays nothing for disposal and improves environmental indicators.

DISCOVER OUR PRODUCTS



Connect Pro Mats

page 6

An innovative two-layer product consisting of a lower-density regranulate layer and an overlay with a low-pore, smooth structure, equipped with a connector system that eliminates board shifting.

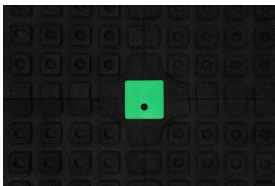

Connect Mats

page 8

A shock-absorbing sports mat with studs that effectively dampens vibrations and protects the building structure from kinetic energy.

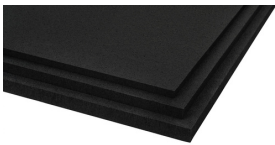

Premium Mats

page 10

Top-quality mats precisely processed using waterjet technology, which guarantees perfect fit of the elements and the highest dimensional stability.



Standard Mats

page 13

Professional SBR granulate surface ensuring durability and safety in cardio and crossfit zones.



Antishock Mats

page 16

A specialized vibration isolation system with a profiled bottom that drastically reduces noise and vibrations when dropping loads.



Underlayer Mats

page 18

A specialized vibroacoustic insulation system installed as an additional layer of the fitness flooring system, designed to maximize noise reduction and protect the screed from damage.

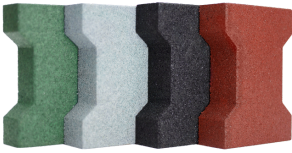

Behaton Rubber Paver

page 20

Behaton type surfacing system with a high coefficient of friction, combining the aesthetics of cobblestone with anti-slip properties.



Weight-Lifting Platforms

page 22

Stable, high-density boards with a drainage system, perfect for heavy-duty areas and livestock facilities.

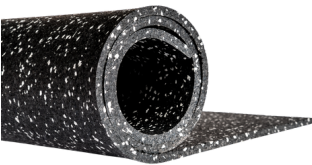

Roll Mats

page 24

A surface for quickly covering large surfaces, creating a uniform and abrasion-resistant base for cardio machines and fitness equipment.



Bumper Plates

page 26

Bumper Olympic plates made of SBR composite, equipped with a steel sleeve ensuring smooth rotation on the bar and protection against corrosion.

SERVICES



Terms of order fulfillment

page 34

At Pavi Sorte, we optimize logistics processes to ensure the highest quality of service while maintaining cost efficiency.

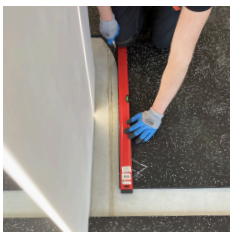

Installation

page 36

Full implementation support provided by specialized installation teams.

CONNECT PRO MATS

An innovative two-layer product. The smooth top layer, manufactured using cold-pressed technology, is characterized by a perfect structure and extreme abrasion resistance.

The profiled, lower-density stud base is a result of the heat-forming process, allowing for the environmentally friendly use of granulate from used flooring. The optional Connect PRO connector system allows the mats to be connected, eliminating the risk of shifting and creating a perfectly uniform, stable surface.

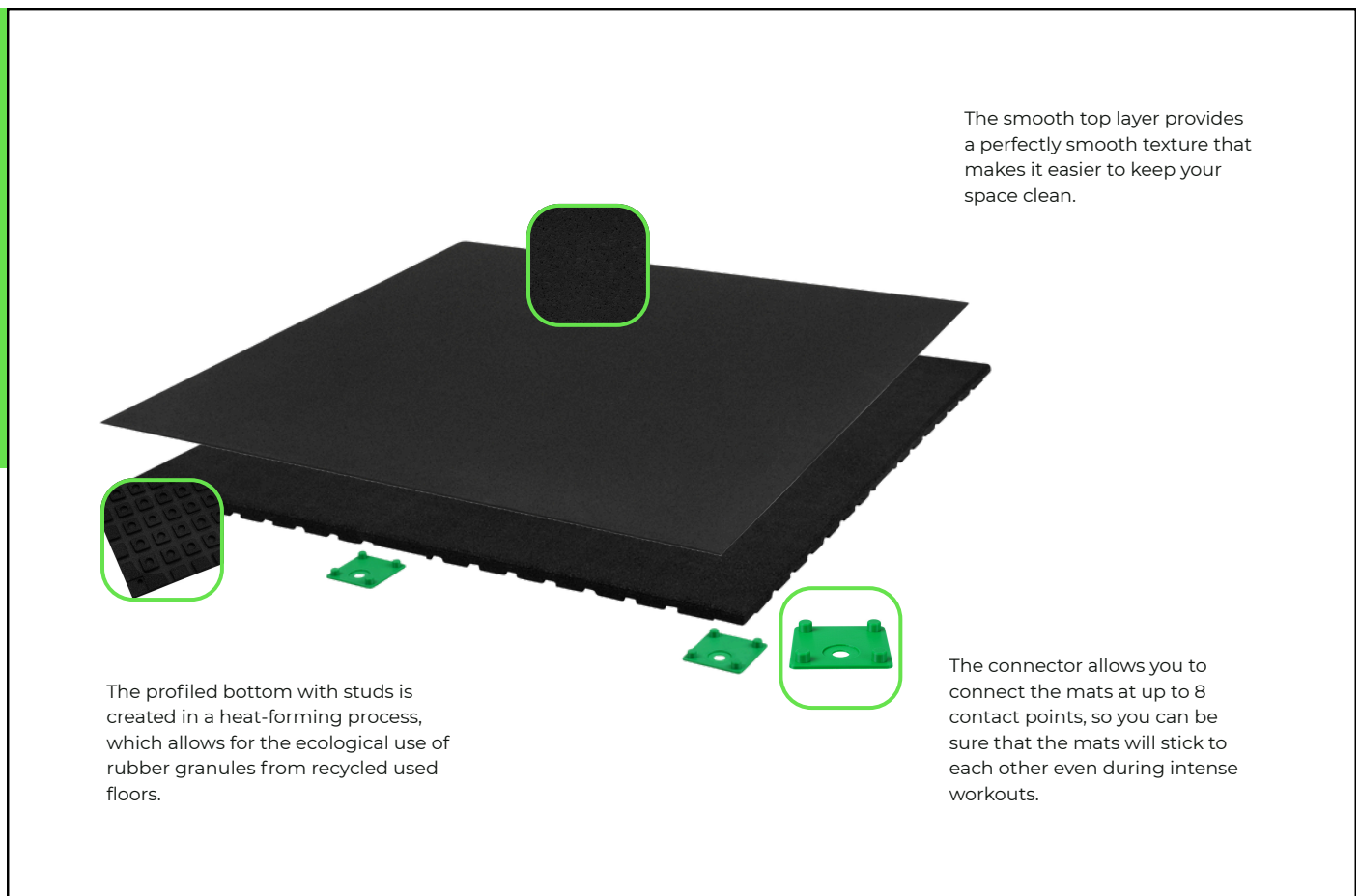

AVAILABLE VARIANTS

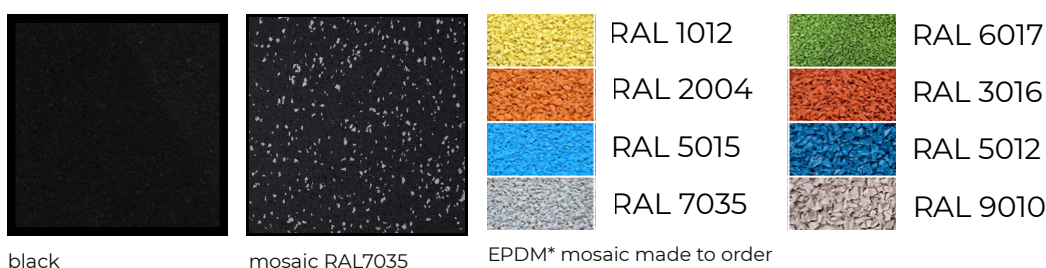



VARIANTS

THICKNESS (mm)	WEIGHT (kg)	MOQ
15	11	1 ton
20	16	1 ton
25	21	1 ton

EXTRAS

OPTIONAL
Classification in terms of reaction to fire Cfl-s2
connector

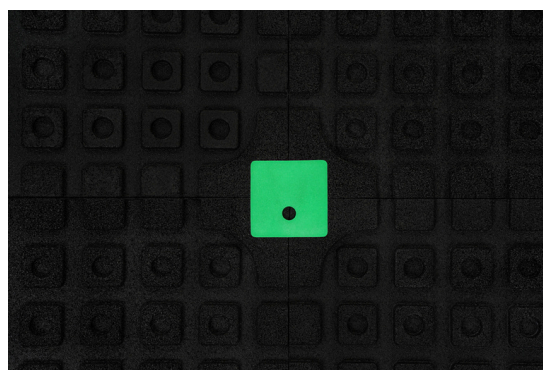
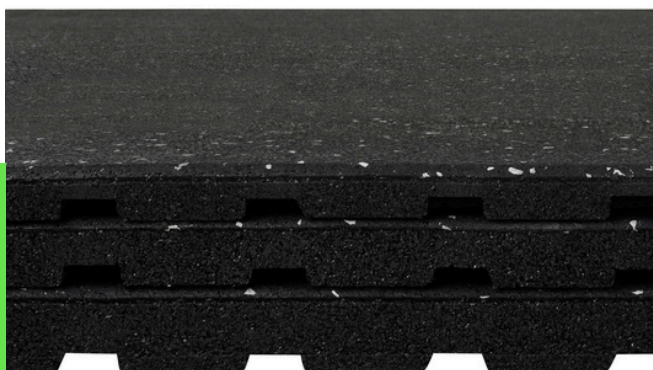
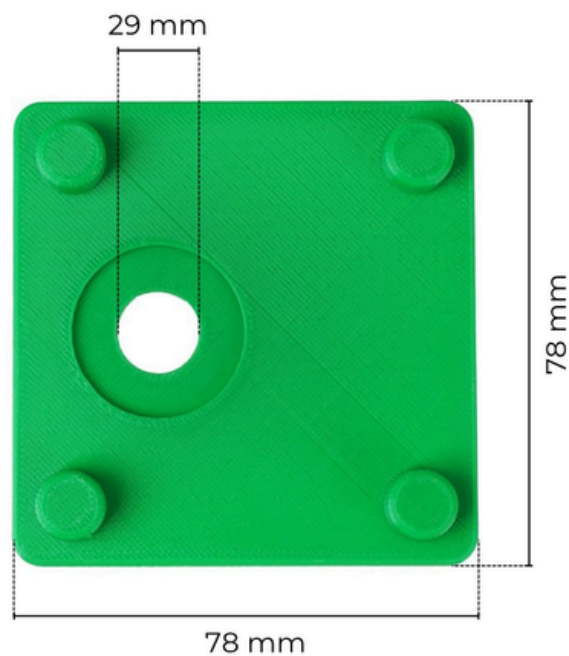
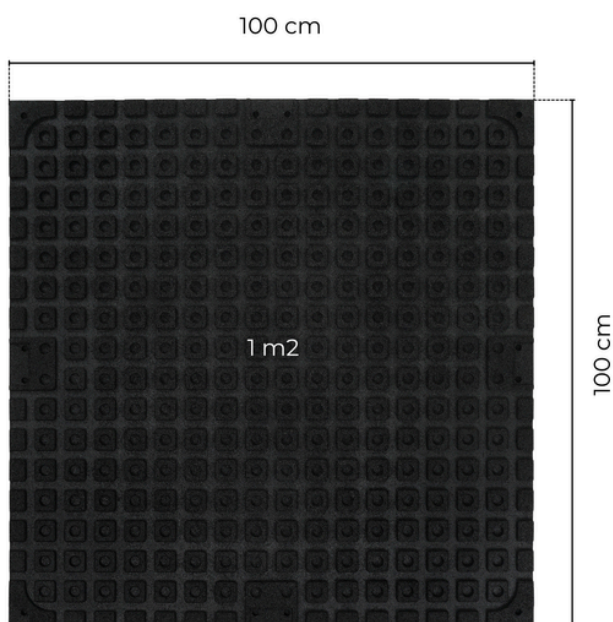

CONNECT MATS

The Connect mat is a specialized shock-absorbing flooring that provides the foundation for professional sports surfaces. Thanks to its profiled, studded underside, the product effectively dampens vibrations and noise, protecting the building structure from kinetic energy.

The lower density of the material provides progressive shock absorption, making it ideal for weightlifting and CrossFit training areas. The connector system also eliminates mat shifting, ensuring stability.

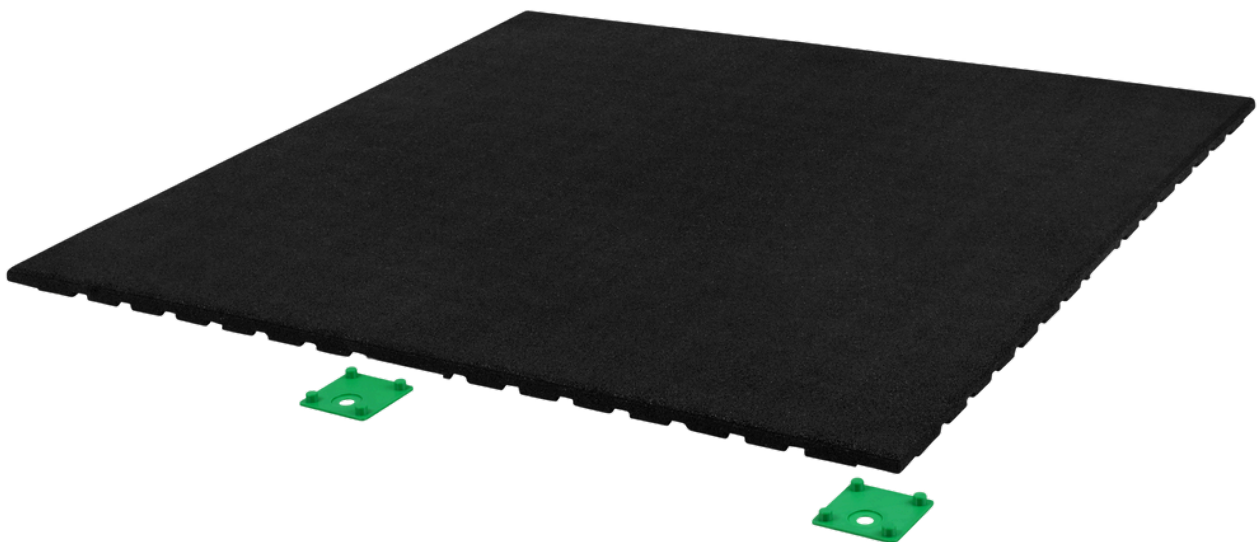

The profiled bottom with studs is created in a heat-forming process, which allows for the ecological use of rubber granules from recycled used floors.

The connector allows you to connect the mats at up to 8 contact points, so you can be sure that the mats will stick to each other even during intense workouts.

AVAILABLE VARIANTS



black

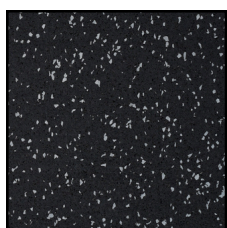

mosaic RAL7035



EPDM* mosaic made to order

RAL 1012

RAL 2004

RAL 5015

RAL 7035

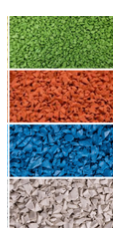

RAL 6017

RAL 3016

RAL 5012

RAL 9010



VARIANTS

THICKNESS (mm)	WEIGHT (kg)	MOQ
15	11	1 ton
20	16	1 ton
25	21	1 ton

EXTRAS

OPTIONAL
Classification in terms of reaction to fire Cfl-s2
mosaic (SBR)
mosaic (EPDM)
connector

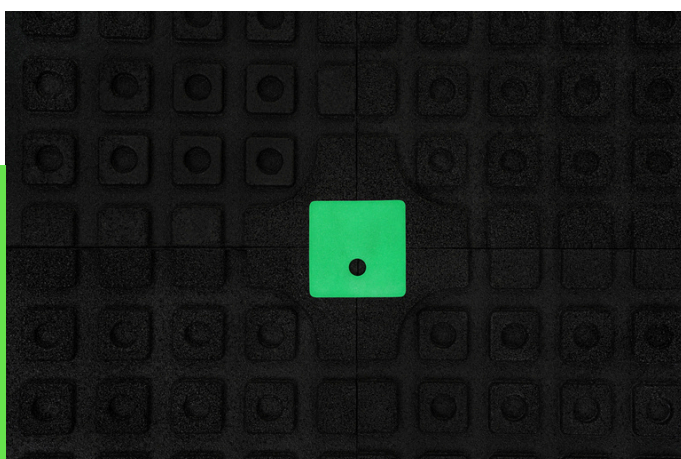
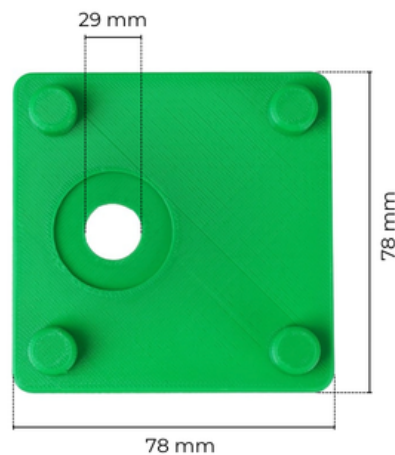
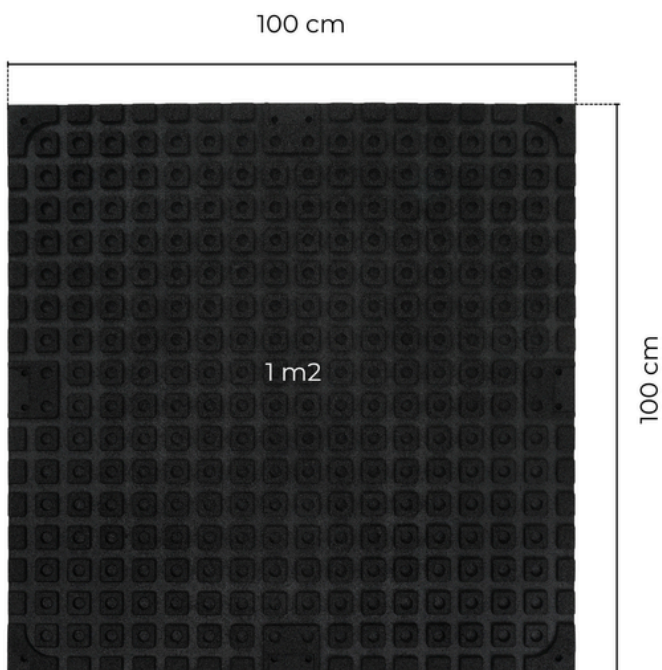

PREMIUM MATS

Premium mats are an advanced surface, precisely processed using waterjet cutting technology.

This process guarantees a perfect fit of the elements, creating a uniform structure that minimizes the risk of dirt accumulation at joints. Designed for high-traffic facilities, it ensures the highest dimensional stability, safe use, and long-term aesthetics.

An advanced surface with a uniform structure, precisely processed using waterjet cutting technology, which guarantees perfect fit of the elements.

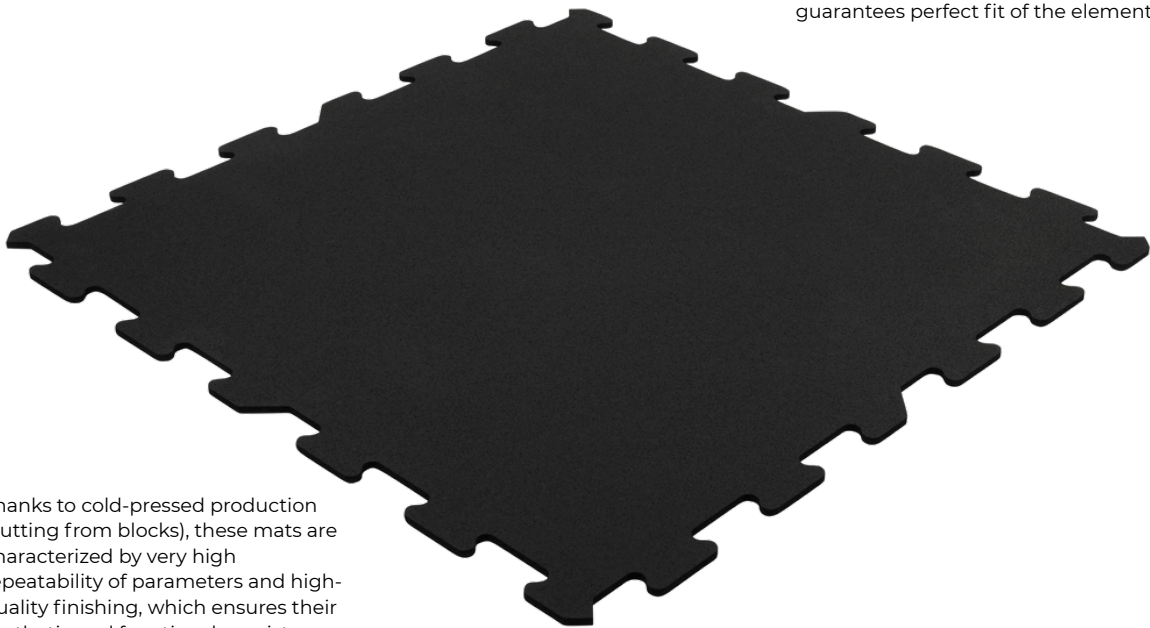

Thanks to cold-pressed production (cutting from blocks), these mats are characterized by very high repeatability of parameters and high-quality finishing, which ensures their aesthetic and functional consistency.

AVAILABLE VARIANTS



black

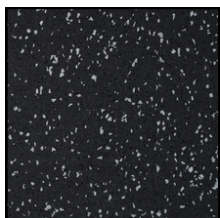

mosaic RAL 7035



EPDM* mosaic made to order

RAL 1012

RAL 2004

RAL 5015

RAL 7035



RAL 6017

RAL 3016

RAL 5012

RAL 9010

***Optional:
Cfl-s2 fire
reaction
classification**



VARIANTS

OTHER DIMENSIONS
50x50 cm
50x100 cm
any other dimension

THICKNESS (mm)	WEIGHT (kg)	MOQ
8	8	-
9	9	-
10	10	-
11	11	-
12	12	-
13	13	-
14	14	-
15	15	-
16	16	-
17	17	-
18	18	-
19	19	-
20	20	-
21	21	-
22	22	-
23	23	-
24	24	-
25	25	-
30	30	-

ENDINGS

OPTION
chamfering the mats around the perimeter
mat ending with a bevel / ramp from one side
mat ending with a bevel / corner ramp (two sides)



PREMIUM MATS

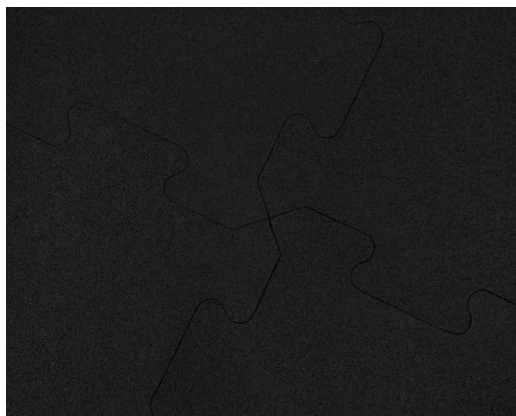
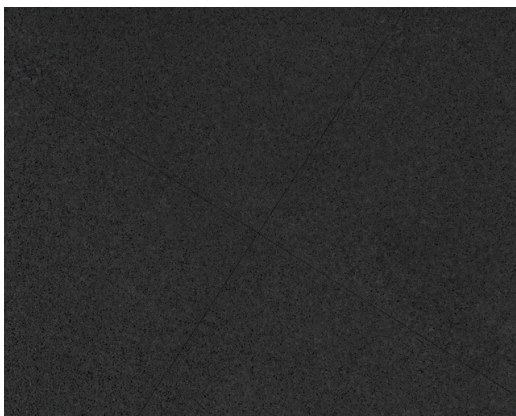
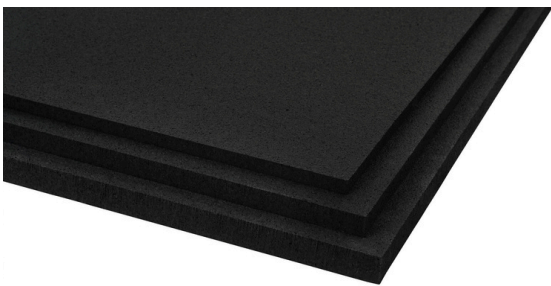
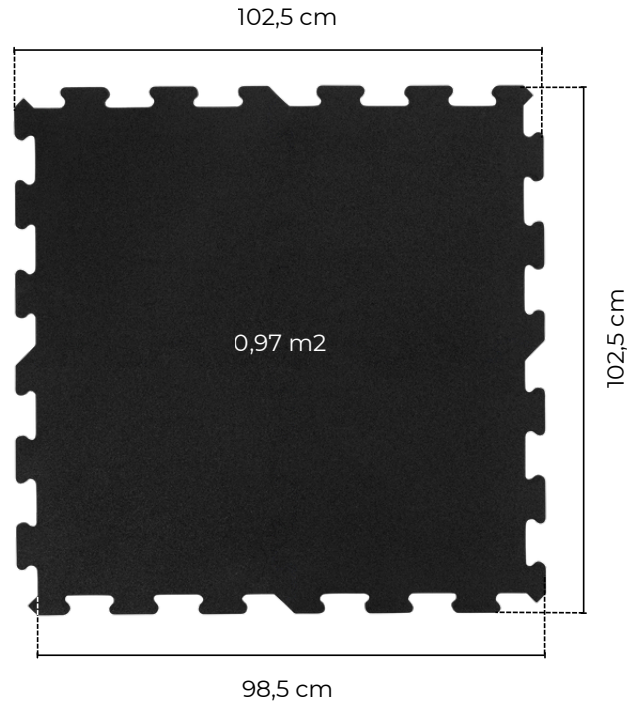
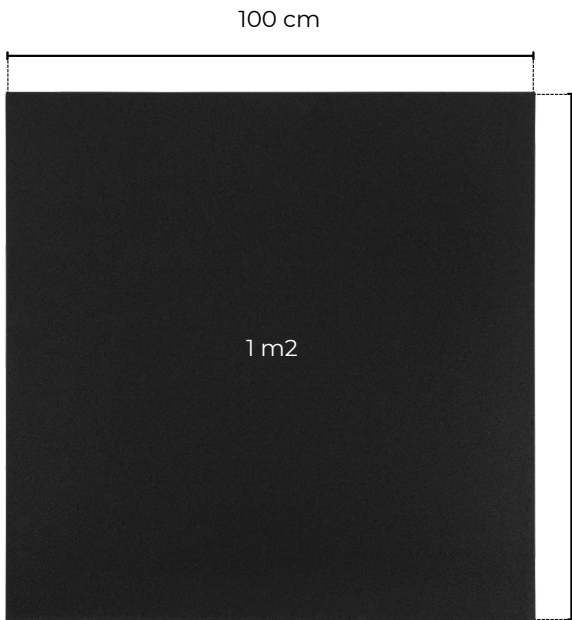

STANDARD MATS

Standard mats are a professional surface made of SBR granules and a PU binder with increased density, guaranteeing long-term material durability.

It enables quick, glue-free installation, optimizing installation costs and reducing facility downtime. It ensures safety in cardio and CrossFit zones. The product effectively protects the floor from damage and dampens noise, directly reducing the total cost of maintaining the training area.

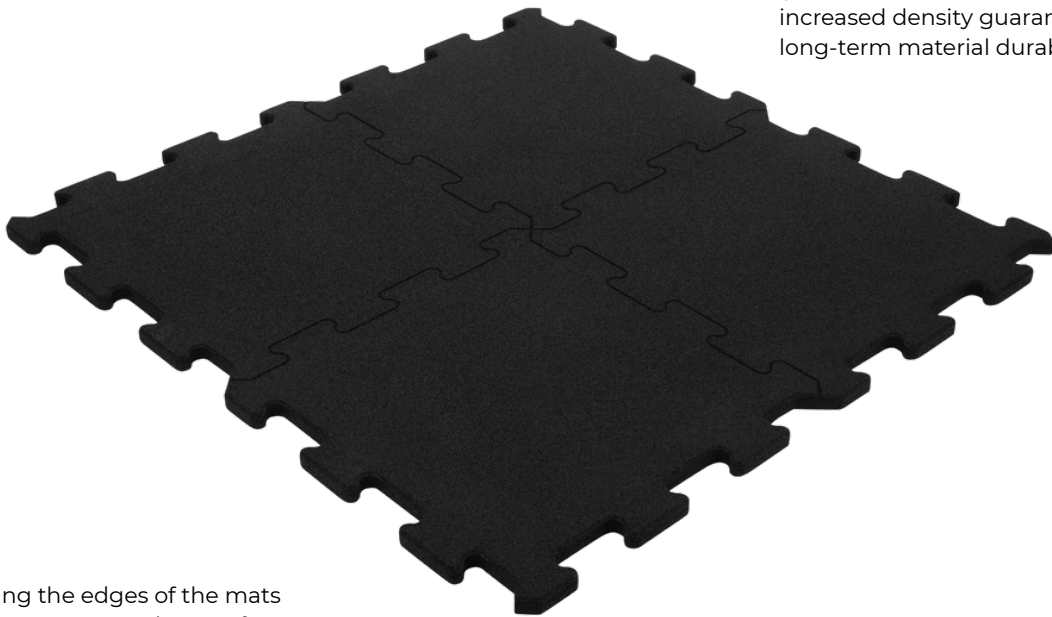

The surface made of SBR granules and PU binder with increased density guarantees long-term material durability.

Beveling the edges of the mats helps to even out minor surface irregularities.

AVAILABLE VARIANTS



black



mosaic RAL 7035



EPDM* mosaic made to order

RAL 1012

RAL 2004

RAL 5015

RAL 7035

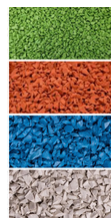

RAL 6017

RAL 3016

RAL 5012

RAL 9010

STANDARD MATS

VARIANTS

THICKNESS (mm)	WEIGHT (kg)	MOQ black	MOQ mosaic
10	10	-	1 ton
15	15	-	1 ton
20	20	-	1 ton
30	30	1 ton	1 ton

EXTRAS

OPTIONAL
Classification in terms of reaction to fire Cfl-s2
mosaic (SBR)
mosaic (EPDM)

ENDINGS

SQUARE	PUZZLE
-	15 mm
20 mm	20 mm
30 mm	-

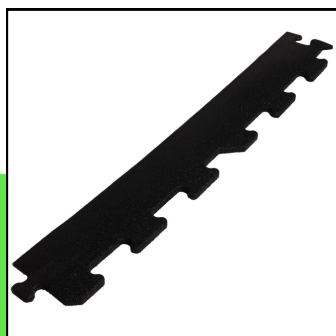

1 YEAR WARRANTY

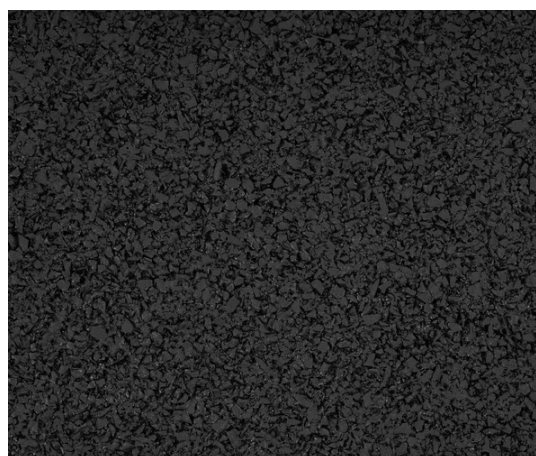
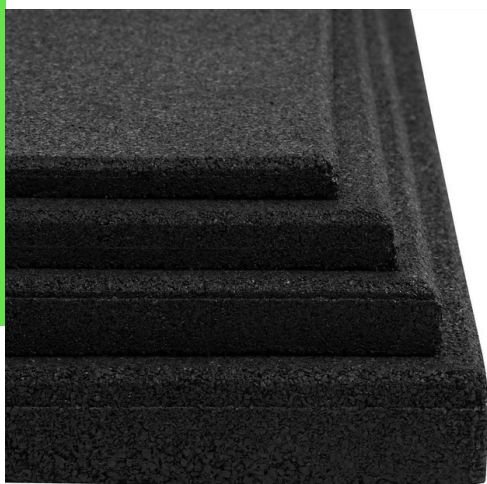
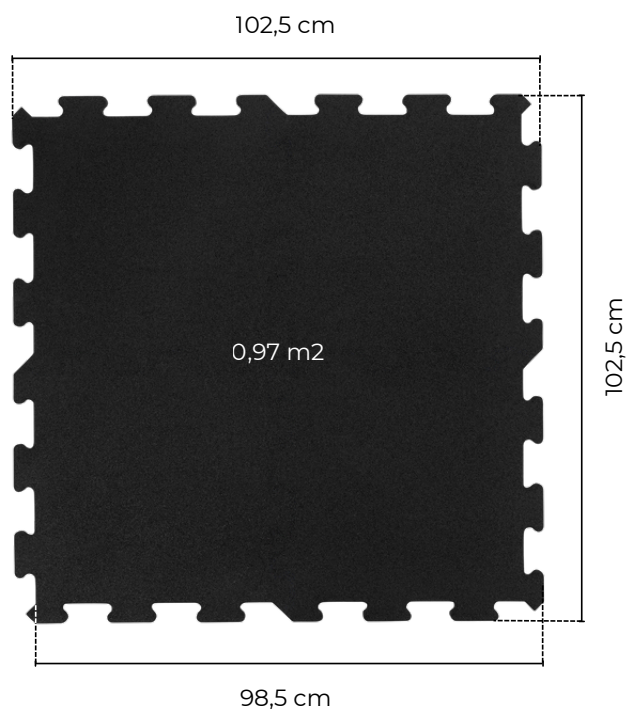
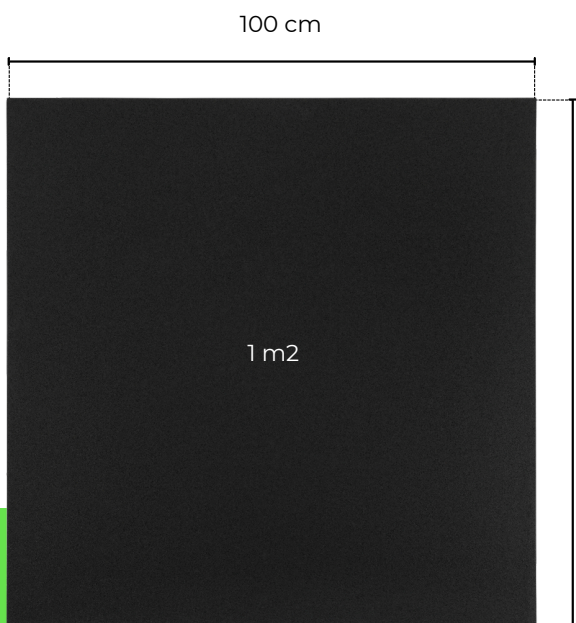

ANTISHOCK MATS

Antishock mats are a specialized vibration-isolating system made of SBR granulate, distinguished by a profiled base (stud structure). They maximize kinetic energy absorption during weight drops and drastically reduce the transmission of noise and vibration into the building structure.

Designed for areas subject to extreme mechanical stress, the product provides a durable and effective protective barrier for ceilings and floors, minimizing the risk of screed cracks and costly infrastructure repairs.

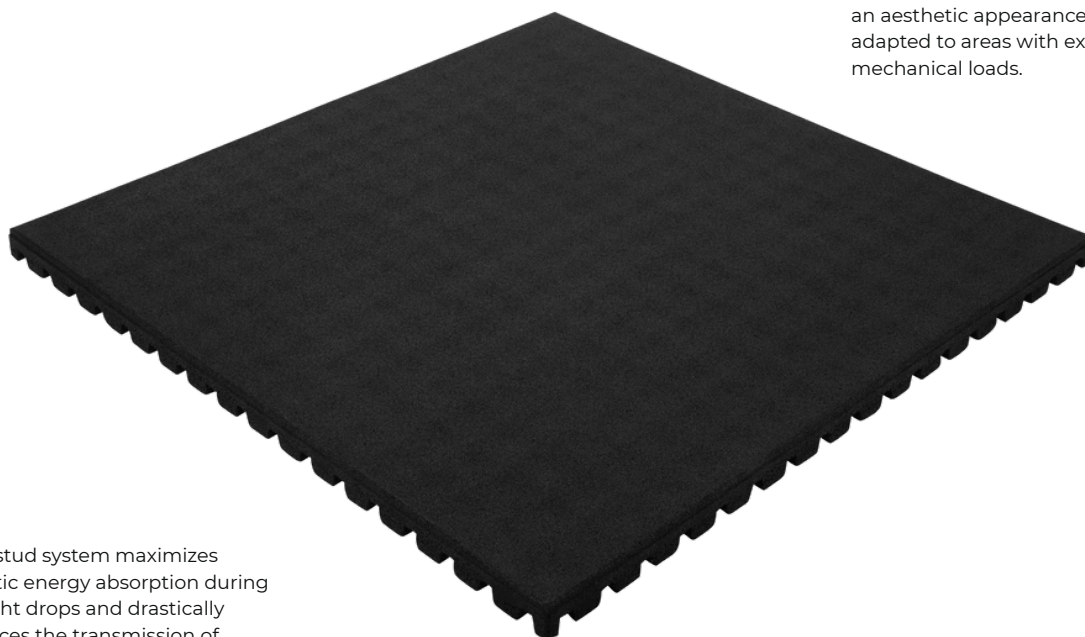

The smooth top layer provides an aesthetic appearance adapted to areas with extreme mechanical loads.

The stud system maximizes kinetic energy absorption during weight drops and drastically reduces the transmission of noise and vibrations to the building structure

AVAILABLE VARIANTS



black

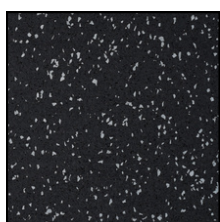

mosaic RAL 7035



EPDM* mosaic made to order

RAL 1012

RAL 2004

RAL 5015

RAL 7035

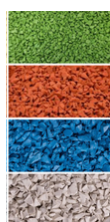

RAL 6017

RAL 3016

RAL 5012

RAL 9010



VARIANTS

THICKNESS (mm)	WEIGHT (kg)	MOQ
25	18	1 ton
30	22	-
35	25	-
43	28	1 ton

EXTRAS

OPTIONAL
Classification in terms of reaction to fire Cfl-s2
mosaic (SBR)
mosaic (EPDM)

ENDINGS

THICKNESS (mm)
25
30
35
43

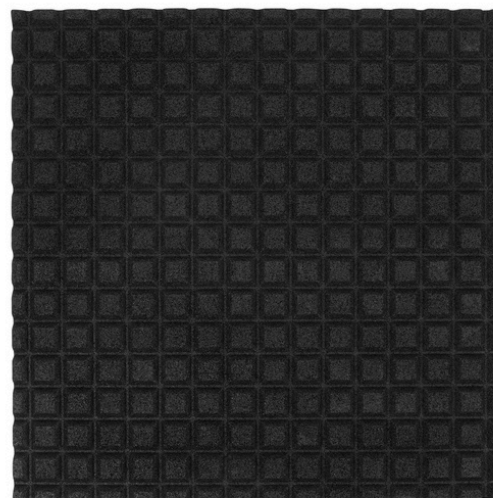
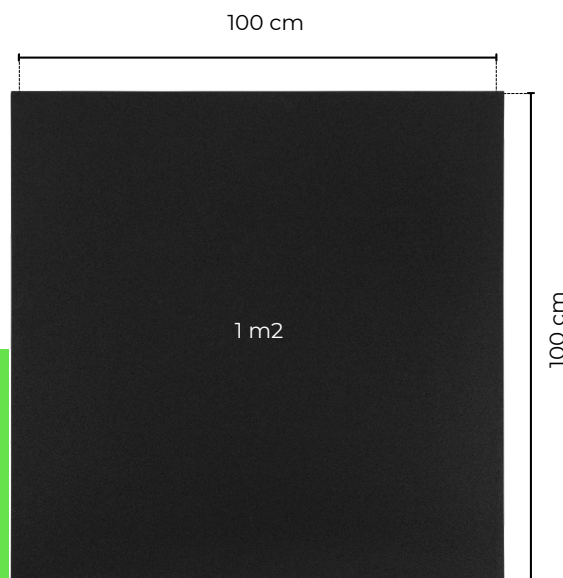
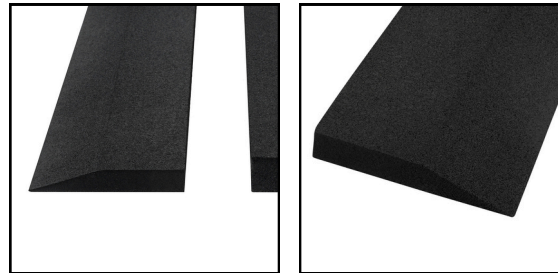

UNDERLAYER MATS

The Underlayer system is a specialized floor foundation, designed as a base layer that protects the screed and building structure against damage and vibration.

This product maximizes kinetic energy absorption and noise reduction while extending the life of the top (target) layer. This solution offers the ability to select the appropriate density and thickness, allowing for precise protection, even on professional truck platforms.

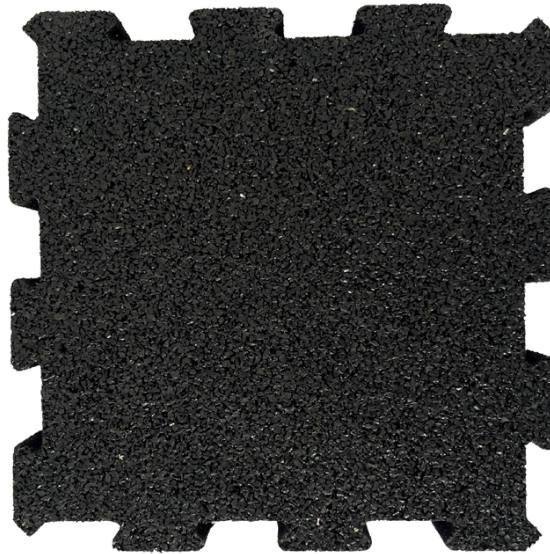

The floor foundation is designed as a protective shield that protects the screed and the building structure against mechanical damage and vibrations.

Maximizes kinetic energy absorption and noise dampening for protection even under professional truck platforms.

AVAILABLE VARIANTS



black



VARIANTS

THICKNESS (mm)	DENSITY (kg/m ³)	DENSITY (kg/m ³)	MOQ
10	550	700	1 ton
15	550	700	1 ton
20	550	700	1 ton
25	550	700	1 ton
30	550	700	1 ton

EXTRAS

OPTIONAL
Classification in terms of reaction to fire Cfl-s2

***other dimensions/densities available upon request - contact the sales representative**

OPTIONS

FORM	DIMENSIONS (cm)	TOLERANCE	COVER (pcs)
puzzle	102x102	< 1 mm	1 m ²
square	110x110	+/-2%	1.2 m ²

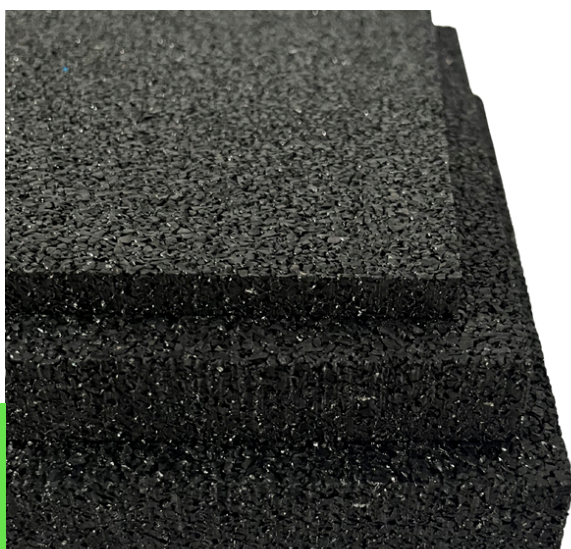

RUBBER PAVER

Behaton rubber paving stones are a surface system that combines the classic aesthetics of paving with the vibration-insulating properties of rubber granules. Thanks to their high coefficient of friction, the product guarantees stability and anti-slip properties even in difficult weather conditions, minimizing the risk of accidents.

It is used in specialist infrastructure (equestrian facilities, communication routes, safe bicycle paths) and recreational infrastructure (terraces, playgrounds).

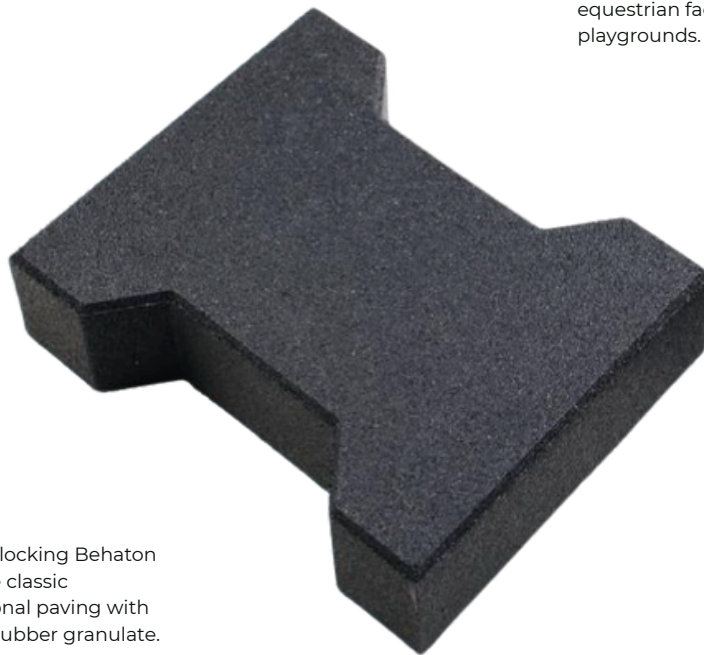

Thanks to its high friction coefficient, it provides anti-slip properties in difficult weather conditions, finding use in equestrian facilities, on bicycle paths and playgrounds.

The distinctive, interlocking Behaton shape combines the classic aesthetics of traditional paving with the functionality of rubber granulate.

AVAILABLE VARIANTS



black

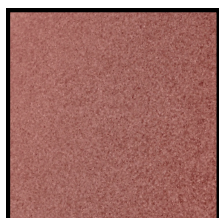

red

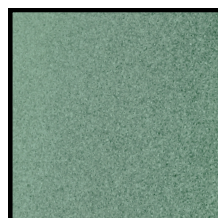

green

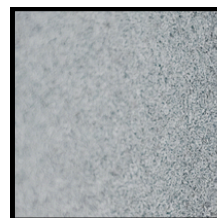

gray



VARIANTS

THICKNESS (mm)	COLOR	WEIGHT (kg/m ²)	QUANTITY (pcs/m ²)	MOQ
43	black	43,2	36	1 ton
43	green	43,2	36	4 tons
43	gray	43,2	36	4 tons
43	red	43,2	36	4 tons

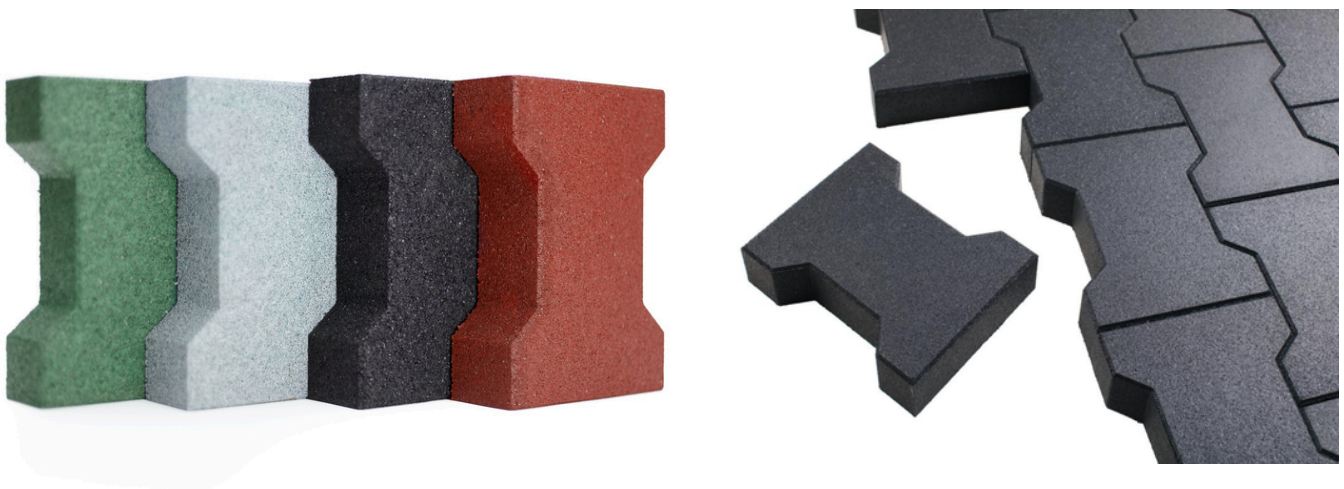
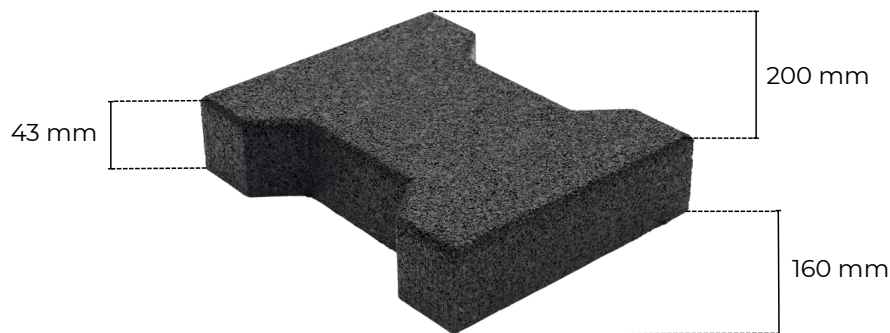

WEIGHT-LIFTING PLATFORM

The 50x50 cm rubber tile system is designed for extreme durability and stability. It's perfect for heavy-duty professional environments.

Thanks to its smaller size and density of 1000–1100 kg/m³, it effectively controls thermal expansion, eliminating the risk of gaps. This also makes it ideal for outdoor applications such as playgrounds and livestock facilities.

This system offers unrivaled acoustic insulation and floor protection, effectively absorbing impacts in professional heavy-duty areas.



A safe dowel connection system ensures the stability of the surface and eliminates the risk of gaps.

AVAILABLE VARIANTS



black

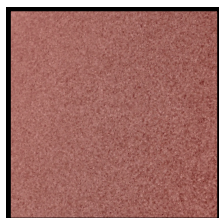

red

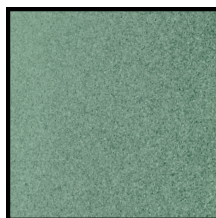

green



VARIANTS

THICKNESS (mm)	WEIGHT (kg/m ³)
30	27
40	36
50	45
60	54
70	63
80	72

*connectors/pins available as a complement to the product

MOQ

COLOR	MOQ
black	1 ton
green	4 tons
red	4 tons

EXTRAS

OPTIONAL

Classification in terms of reaction to fire Cfl-s2

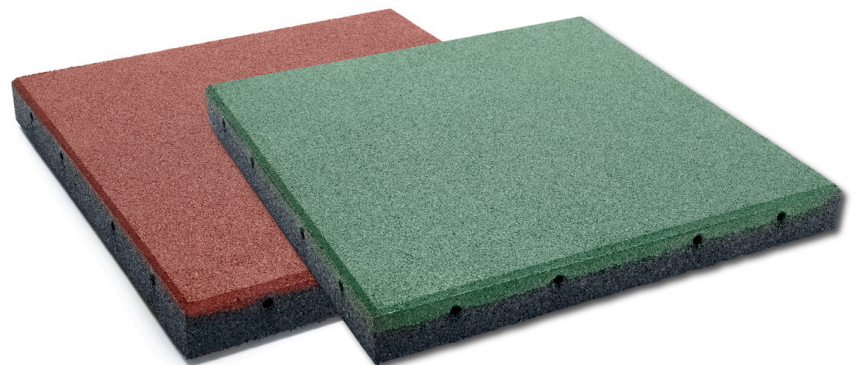
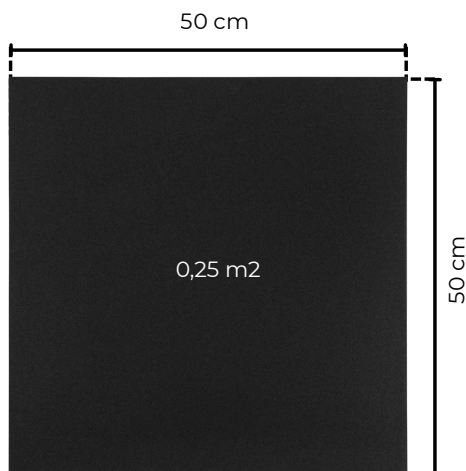

ROLL MAT

Rolled Mat is a surface system designed to quickly cover large surfaces. It minimizes the number of joints, creating a uniform, aesthetically pleasing structure. The material's high density and abrasion resistance guarantee durability, even in passageways and functional areas.

The mat has excellent vibration-insulating and anti-slip properties, providing a stable base for cardio machines and fitness equipment, while protecting the floor from scratching and point pressure.



Quick coverage of large surfaces, minimizing the number of joints, creating a uniform and aesthetic structure.

Thanks to its high density and vibration-insulating and anti-slip properties, the mat provides a stable base for cardio machines, effectively protecting the floor against scratches and point pressure.

AVAILABLE VARIANTS



black

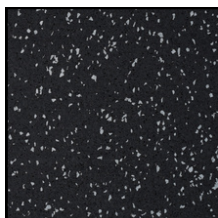

mosaic

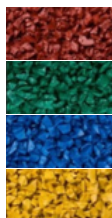

RAL 3016

RAL 6016

RAL 5015

RAL 1012



RAL 7038

RAL 9010



VARIANTS

THICKNESS (mm)	DIMENSIONS (m)	WEIGHT (kg)
3	1,2 x 10	29
4	1,2 x 10	39
6	1,2 x 10	59
8	1,2 x 10	78
10	1,2 x 10	97
12	1,2 x 10	117

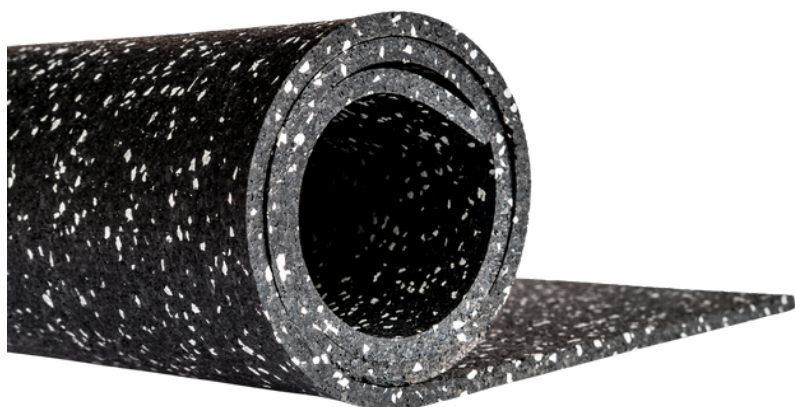

STANDARD BUMPER PLATES

Bumper Olympic weights are training plates based on a composite of recycled SBR granules.

The central design element is a stainless steel bushing that prevents deformation of the mounting hole and corrosion, ensuring smooth rotation on the bar and an extended product life cycle.

The product is available in weights of 5, 10, 15, 20 and 25 kg, as well as in ready-made sets with a total weight of 100 kg or 150 kg.



51mm diameter stainless steel bushing that prevents corrosion and ensures smooth rotation on the bar.

AVAILABLE VARIANTS



black



mosaic



RAL 1012



RAL 2004

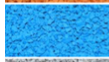

RAL 5015



RAL 7035

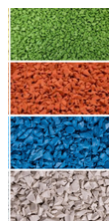

RAL 6017



RAL 3016



RAL 5012



RAL 9010



VARIANTS

WEIGHT (kg)	PLATE THICKNESS (mm)
5	30
10	60
15	90
20	120
25	120
set 100 kg	600
set 150 kg	840

MOQ

PRODUCT	MOQ
bumper ST "no name"	-
bumper ST mosaic	4 tons (min. 80 pcs/weight)
bumper CUSTOM	4 tons (min. 80 pcs/weight)

EXTRAS

OPTIONAL
mosaic
cardboard packaging
foil packaging

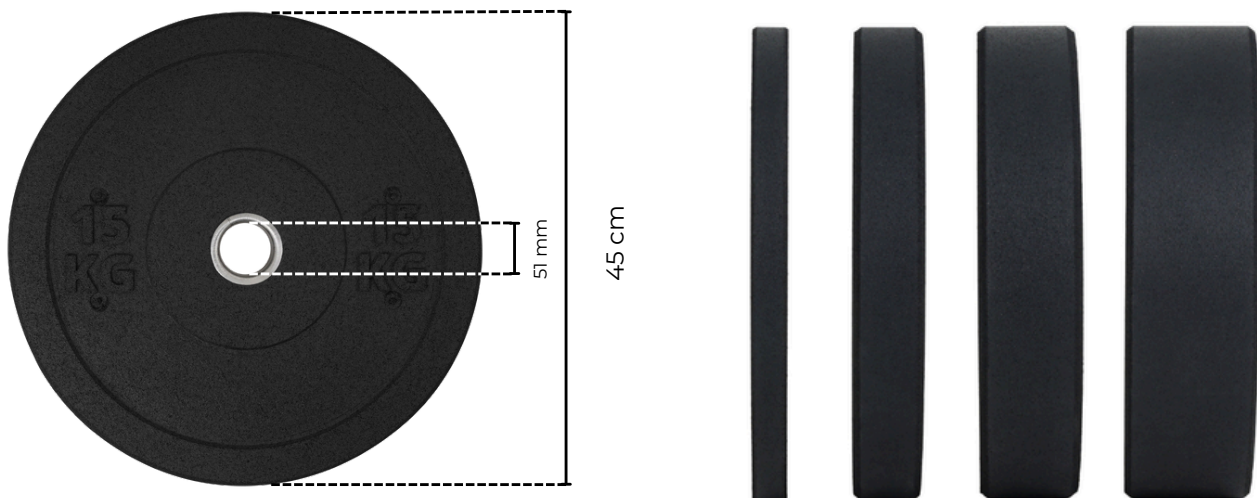

PRO BUMPER PLATES

Bumper Mosaic Pro are advanced composite plates with a reduced thickness profile, dedicated to professional weightlifting and CrossFit zones.

Optimizing the dimensions allows for maximizing the working load on the bar bushing, increasing the usability of the equipment for advanced training groups without the need to invest in specialized barbells.

Advanced rubber plates with a reduced thickness profile, allowing for maximum working load on the bar bushing.



A stainless steel bushing that prevents corrosion and deformation of the mounting hole, ensuring smooth rotation on the bar.

AVAILABLE VARIANTS



black

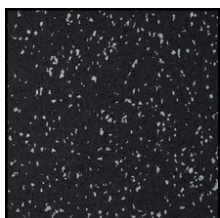

mosaic



RAL 1012



RAL 2004



RAL 5015



RAL 7035

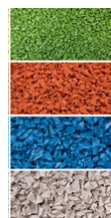

RAL 6017



RAL 3016



RAL 5012



RAL 9010



VARIANTS

WEIGHT (kg)	PLATE THICKNESS (mm)
5	30
10	50
15	65
20	80
25	98
set 100 kg	450
set 150 kg	646

EXTRAS

OPTIONAL
mosaic
cardboard packaging
foil packaging

MOQ

PRODUCT	MOQ
bumper PRO black	4 tons (min. 80 pcs/weight)
bumper PRO mosaic	4 tons (min. 80 pcs/weight)
bumper CUSTOM	4 tons (min. 80 pcs/weight)

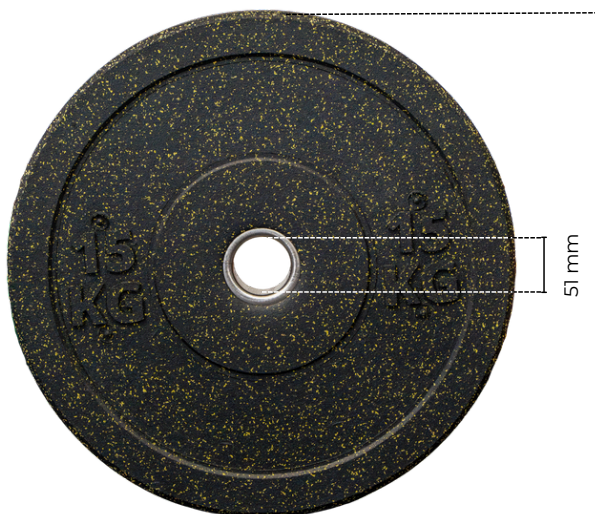

45 cm



OUR PROJECTS



Product: Square Pro Mats
mosaic 5% RAL 7035,
15 mm

Location: Zielonki (Lesser
Poland Voivodeship)

Service: dimensioning,
design, production,
assembly

OUR PROJECTS

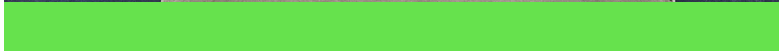

Product: Puzzle Pro Mats,
20 mm
Location: AWF Warsaw
Service: design, production,
assembly

OUR PROJECTS

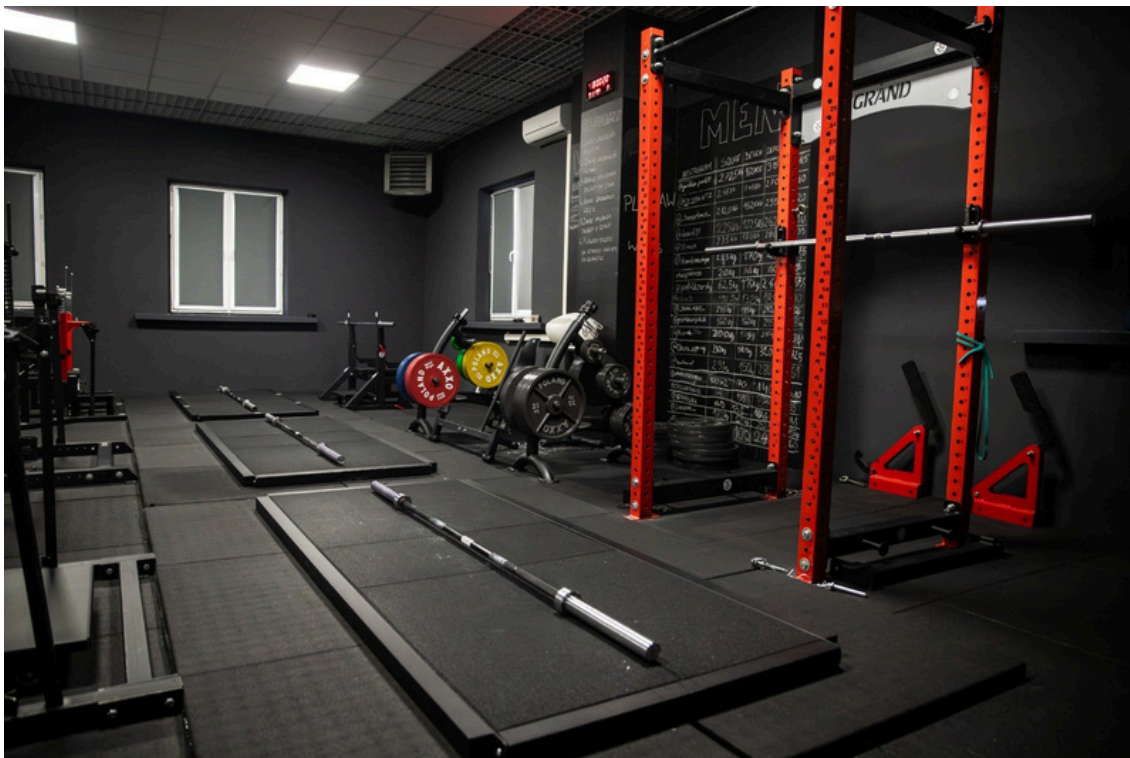

Product: Antishock Mats, 43 mm
Location: GymCity training studio
Service: production

OUR PROJECTS

Product: Standard Puzzle Mat,
15 mm

Location: 600 m² gym,
Szczecin

Service: production



TERMS OF ORDER FULFILLMENT

At Pavi Sorte, we optimize logistics processes to ensure the highest quality of service while maintaining cost efficiency.

FLEXIBLE LOGISTICS MODELS:



D2D delivery: comprehensive delivery organization by our logistics department.

Dropshipping: shipping directly to the end customer or small batches to the partner's warehouse.

Customer's own transport: possibility of collecting the goods yourself or providing your own carrier.

Planned deliveries: periodic deliveries for regular partners, optimizing storage costs.

SMALL ORDER POLICY (DROPSHIPPING):

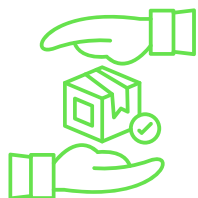

Logistics surcharge: all orders with a total weight below 1 ton are classified as dropshipping.

Handling costs: a flat fee of €40 is charged for orders under 1 ton. If you require individual terms, please contact us.

MOQ FOR CUSTOM PRODUCTS:

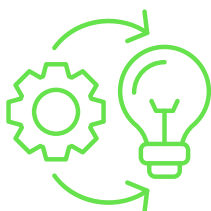

Colors and mosaics: colors from the RAL palette are realized upon individual request (except RAL 7035)

Formats: the possibility of producing mats in non-standard shapes and thicknesses is always confirmed by the sales department based on current production capabilities.

*The data presented in the catalogue are for illustrative purposes only and do not constitute official technical parameters of the products.

To obtain specifications and detailed technical data sheets, please contact our sales representative directly.

DROPSHIPING

Pavi Sorte's dropshipping model eliminates warehousing and capital lock-up costs, offering complete flexibility thanks to its lack of MOQ.

We guarantee operational security through an OTIF rate of 98.5% and direct D2D deliveries that shorten the supply chain to a minimum.

It is a strategic tool for building market advantage without the risk of excess inventory (overstocking).



No need to store goods



No need to freeze capital



OTIF reliability and on-time delivery guarantee

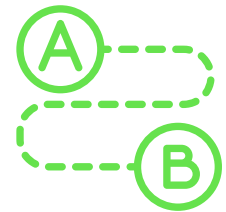

D2D delivery directly to the end customer



ASSEMBLY SERVICE

We provide full installation support, taking responsibility for precise paving in accordance with design documentation and stringent safety standards.



Our specialized installation teams guarantee efficient investment implementation, allowing for quick commissioning of the facility while maintaining the highest aesthetics and durability of the system.

As a manufacturer and contractor in one, we take full responsibility for the final result, eliminating the risk of errors between product delivery and installation.

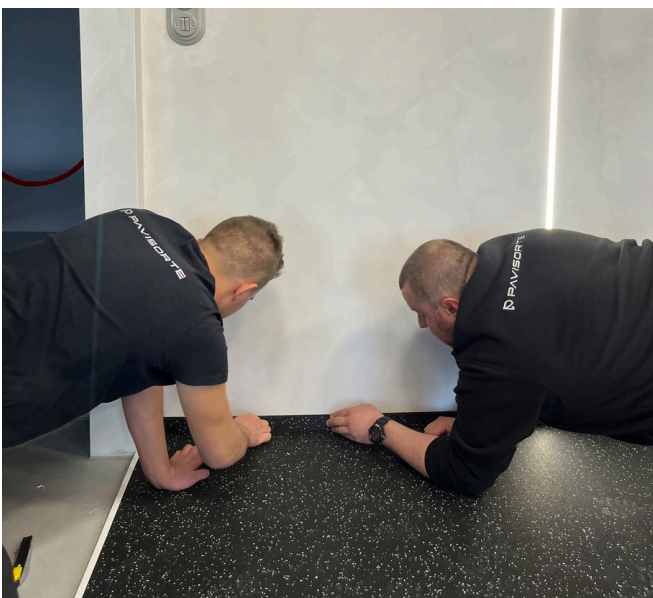

GIVE NEW LIFE TO YOUR WORN FLOOR



Our commitment to the circular economy provides real support for your business.

We offer comprehensive collection of used rubber surfaces, relieving you of the hassle and expense of disposal. The service itself is virtually free (it costs a symbolic 1 €), and all you have to do is organize the transport of the material to our facility.

PAVISORTE



sylwiauchto@pavisorte.com



+48 662 976 591



www.linkedin.pl/company/pavisorte



Pavi Sorte sp. z o.o.
Brzozówka 20C
32-340 Wolbrom

NIP: 6372205055
REGON: 381038154
KRS: 0000745343

We help you open clubs faster and reduce the total cost of your sports surfaces.

PRODUCTION, CONSULTING, LOGISTICS AND RECYCLING
– FULL SERVICE IN ONE PLACE.

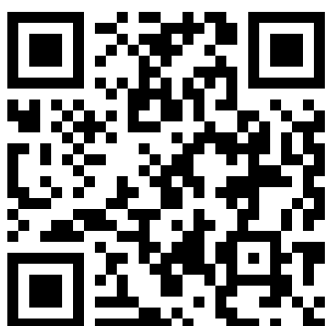

DOWNLOAD THE MOBILE VERSION OF THE CATALOG

www.pavisorte.com/katalog

Contact us:



sylwiauchto@pavisorte.com



+48 662 976 591

OBCIĄŻENIA STANDARD



PODARUJ NOWE ŻYCIE SWOJEJ ZUŻYTEJ PODŁODZE

Nasze zaangażowanie w gospodarkę o obiegu zamkniętym to realne wsparcie dla Twojego biznesu.



Oferujemy kompleksowy odbiór zużytej nawierzchni gumowej, zdejmując z Państwa barków problematyczną i kosztowną utylizację. Sama usługa jest w praktyce bezpłatna (jej koszt to symboliczna złotówka), a po Państwa stronie pozostaje jedynie organizacja transportu materiału do naszego zakładu.

OBCIĄŻENIA PREMIUM

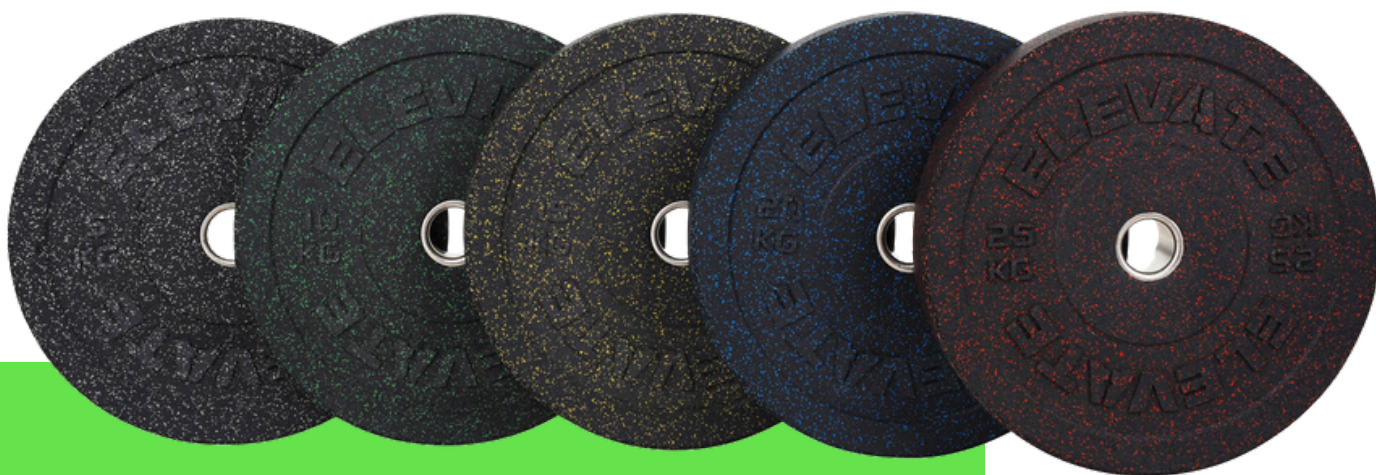





HISTORIA PISANA WSPÓLNIE

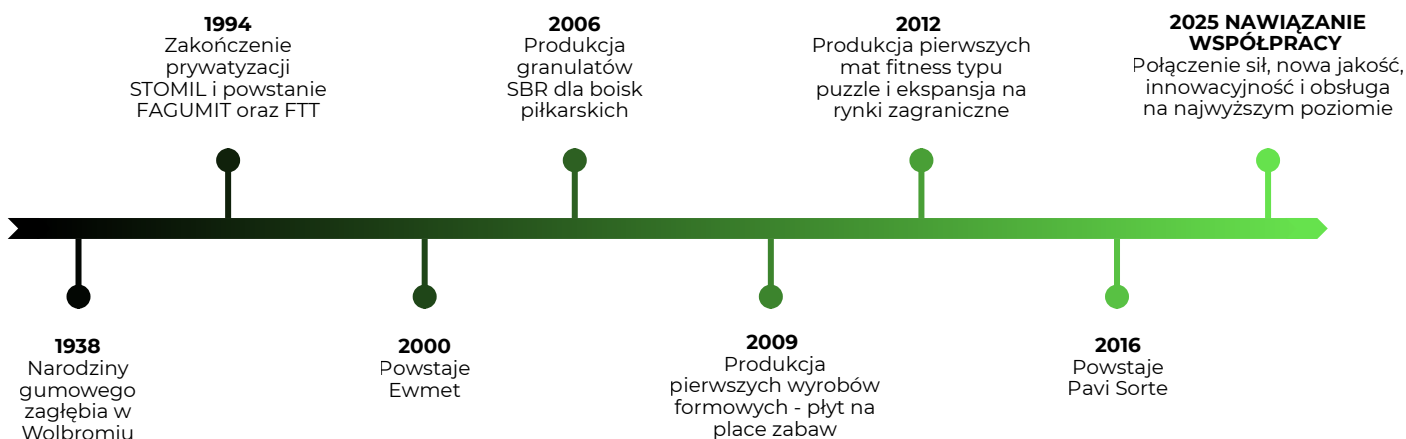

CO NASZA WSPÓŁPRACA OZNACZA W PRAKTYCE?



NOWA GAMA PRODUKTÓW PREMIUM

Poszerzamy ofertę o najwyższej klasy maty produkowane w innowacyjnej technologii. Gwarantuje to precyzję i wyjątkową trwałość.



GOTOWE ROZWIĄZANIA NAWET W 7 DNI

Realizujemy zamówienia na nawierzchnie do 500 m² w terminie do 7 dni roboczych, bez zbędnych opóźnień.



NIEZMIENNIE NAJWYŻSZA JAKOŚĆ OBSŁUGI

Zachowujesz wszystko, co cenisz w Pavi Sorte: elastyczność, błyskawiczną obsługę i pełne wsparcie w procesie zakupowym

ZOBACZ ILE MOŻESZ OSZCZĘDZIĆ

Zmaksymalizuj swoją zniżkę (aż do 6%), łącząc różne produkty w ramach jednego transportu i wybierając opcję płatności 100% przedpłaty.

- 💰 7 ton (palet) maty Puzzle Standard 15mm = **rabat 2%**
- 💰 7 ton (palet) maty Puzzle Standard 15mm + przedpłata 100% = **rabat 4%**
- 💰 15 ton (palet) maty Puzzle Standard 15mm = **rabat 4%**
- 💰 15 ton (palet) maty Puzzle Standard 15mm + przedpłata 100% = **rabat 6%**
- 💰 3 tony (palety) maty Puzzle Standard 15mm + 4 tony (palety) maty Connect Pro 20mm = **rabat 2%**

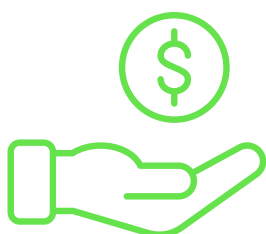

Przy zamówieniach pełnopojazdowych (24 tony) istnieje możliwość indywidualnego rabatowania.



POZNAJ NASZE PRODUKTY



Maty Connect Pro

strona 5

Innowacyjny produkt dwuwarstwowy o ekstremalnej wytrzymałości na ścieranie, wyposażony w system łączników eliminujący przesuwanie się płyt.

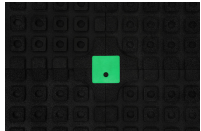

Maty Connect

strona 7

Amortyzujący podkład sportowy z wypustkami, który skutecznie tłumi wibracje i chroni strukturę budynku przed energią kinetyczną.

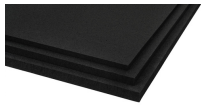

Maty Premium

strona 9

Zaawansowane maty poddane precyzyjnej obróbce technologią waterjet, która gwarantuje idealne spasowanie elementów i najwyższą stabilność wymiarową.



Maty Standard

strona 14

Profesjonalna nawierzchnia z granulatu SBR zapewniająca trwałość oraz bezpieczeństwo w strefach cardio i crossfit.



Maty Antishock

strona 18

Specjalistyczny system wibroizolacyjny z profilowanym spodem, który drastycznie redukuje hałas i drgania przy zrzutach ciężarów.



Maty Underlayer

strona 21

Wysokospecjalistyczna tarcza ochronna pod posadzki, zaprojektowana w celu maksymalnego wygłuszenia hałasu i zabezpieczenia wylewki przed uszkodzeniami.

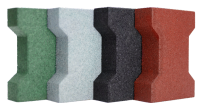

Kostka gumowa Behaton

strona 23

System nawierzchniowy typu Behaton o wysokim współczynniku tarcia, łączący estetykę bruku z właściwościami antypoślizgowymi.

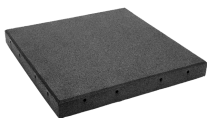

Podesty ciężarowe

strona 25

Stabilne płyty o wysokiej gęstości z systemem drenażu, doskonale sprawdzające się w strefach Heavy-Duty i obiektach inwentarskich.

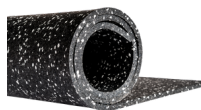

Maty w rolce

strona 27

Nawierzchnia do szybkiego pokrywania dużych powierzchni, tworząca jednolitą i odporną na ścieranie bazę pod maszyny cardio oraz sprzęt fitness.



Bumpery

strona 29

Talerze olimpijskie typu Bumper z kompozytu SBR, wyposażone w stalową tuleję zapewniającą płynną rotację na gryfie i ochronę przed korozją.

MATY PREMIUM



MATY STANDARD

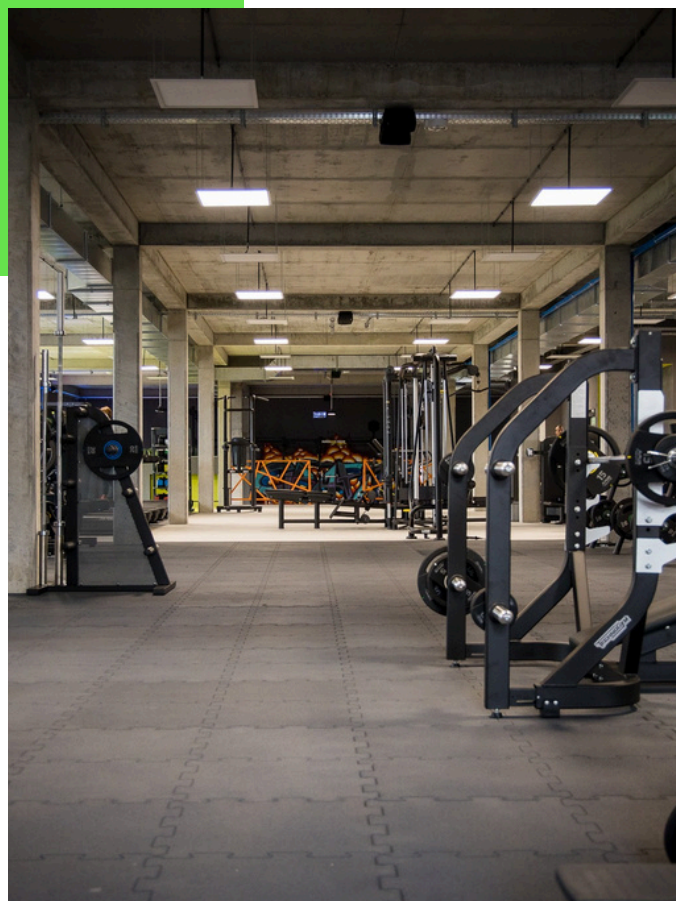

MATY ANTISHOCK



MATY PREMIUM

WARIANTY

GRUBOŚĆ (mm)	WAGA (kg)	MOQ
8	8	-
9	9	-
10	10	-
11	11	-
12	12	-
13	13	-
14	14	-
15	15	-
16	16	-
17	17	-
18	18	-
19	19	-
20	20	-
21	21	-
22	22	-
23	23	-
24	24	-
25	25	-
30	30	-

***Potrzebujesz oferty spoza cennika?
Skontaktuj się z handlowcem aby
otrzymać ofertę dopasowaną do
Twoich potrzeb!**

POMAGAMY OTWIERAĆ KLUBY SZYBCIEJ I OBNIŻAĆ CAŁKOWITY KOSZT NAWIERZCHNI SPORTOWYCH.

Co zyskujesz dzięki współpracy z nami?



Dostawa D2D: kompleksowa obsługa odbioru, transportu i dostawy Państwa przesyłek bezpośrednio od nadawcy do odbiorcy



Pełna elastyczność finansowa (no MOQ dla bestsellerów): zamawiasz tylko tyle ile potrzebujesz i nie mrozisz gotówki w towarze



Jeden partner, wiele możliwości: oferujemy doradztwo, projektowanie, produkcję i montaż nawierzchni - Ty tylko wnosisz sprzęt i możesz otwierać lokal



Wsparcie i gwarancja jakości: najwyższa jakość produktów, a także partnerstwo, które rozumie i wspiera Twój biznes



Ekologiczne rozwiązanie: odbierzemy i przerobimy Twoją zużytą podłogę na granulację - korzyść dla Ciebie i środowiska



Bezpieczeństwo i pewność realizacji: jesteśmy w stanie wyprodukować nawet 3000 ton nawierzchni miesięcznie co gwarantuje ciągłość i terminowość dostaw

**PAVI SORTE I EWMET DZIAŁAJĄ NA RYNKU WYROBÓW GUMOWYCH
OD 2000 ROKU**

WSPÓLNIE WYPRODUKOWALIŚMY PONAD 50 000 TON PRODUKTÓW